

Faria®

Pilot System

Installation and Operation Guide

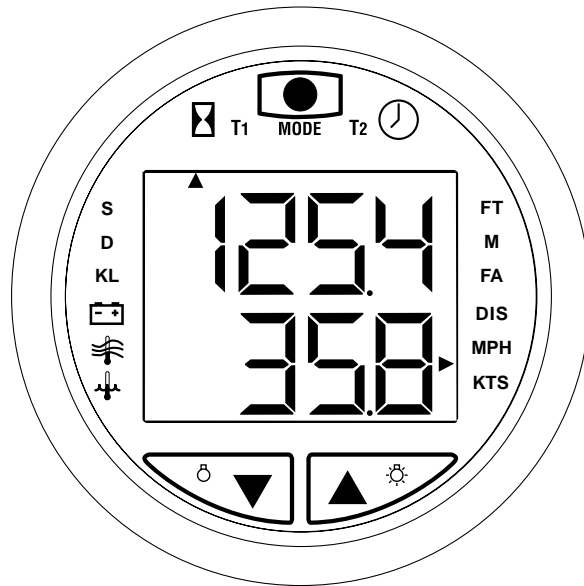

Faria® **MARINE**
INSTRUMENTS

ISO 9001 Registered

385 Norwich-New London Turnpike, Uncasville, CT USA 06382-0983
Tel: (860)-848-9271 Fax: (860)-848-2704 Customer Service: (800)-473-2742 ext.1229
Internet: www.faria-instruments.com e-mail faria@faria-instruments.com

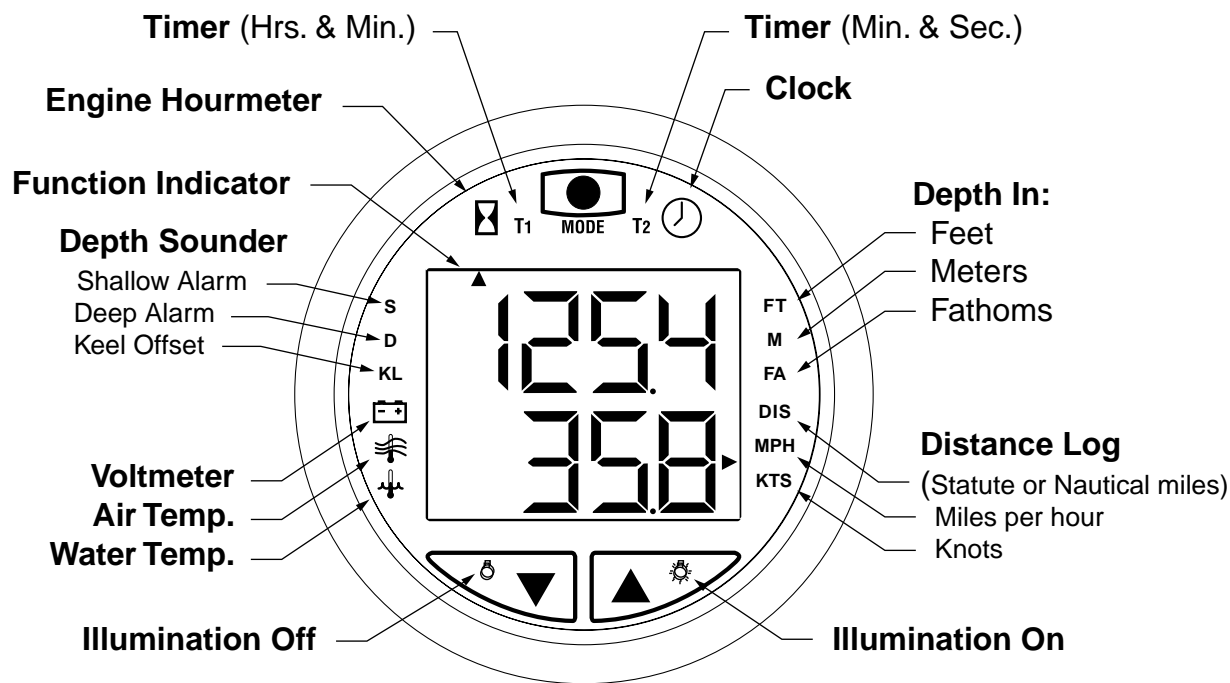

Key Pad Functions

Description:

The Faria Pilot System is a multifunctional instrument designed to give two simultaneous readouts of several different and independent functions on an upper and lower LCD display. The illustration above shows the various functions provided by the instrument.

WARNING: The depth sounder is not to be used for navigation or as a device to avoid grounding which may result in boat damage or personal injury. Always use caution operating in shallow areas and maintain a very slow speed. Be aware that depths may change too quickly for you to avoid grounding.

Index:

Installation.....	2
Operation.....	3
 Upper Display Functions	
Depth Finder.....	3
Timer.....	4
Clock.....	4
Hourmeter.....	5
 Lower Display Functions	
Speedometer & Distance Log.....	5
Air & Water Temperature.....	6
Voltmeter.....	6

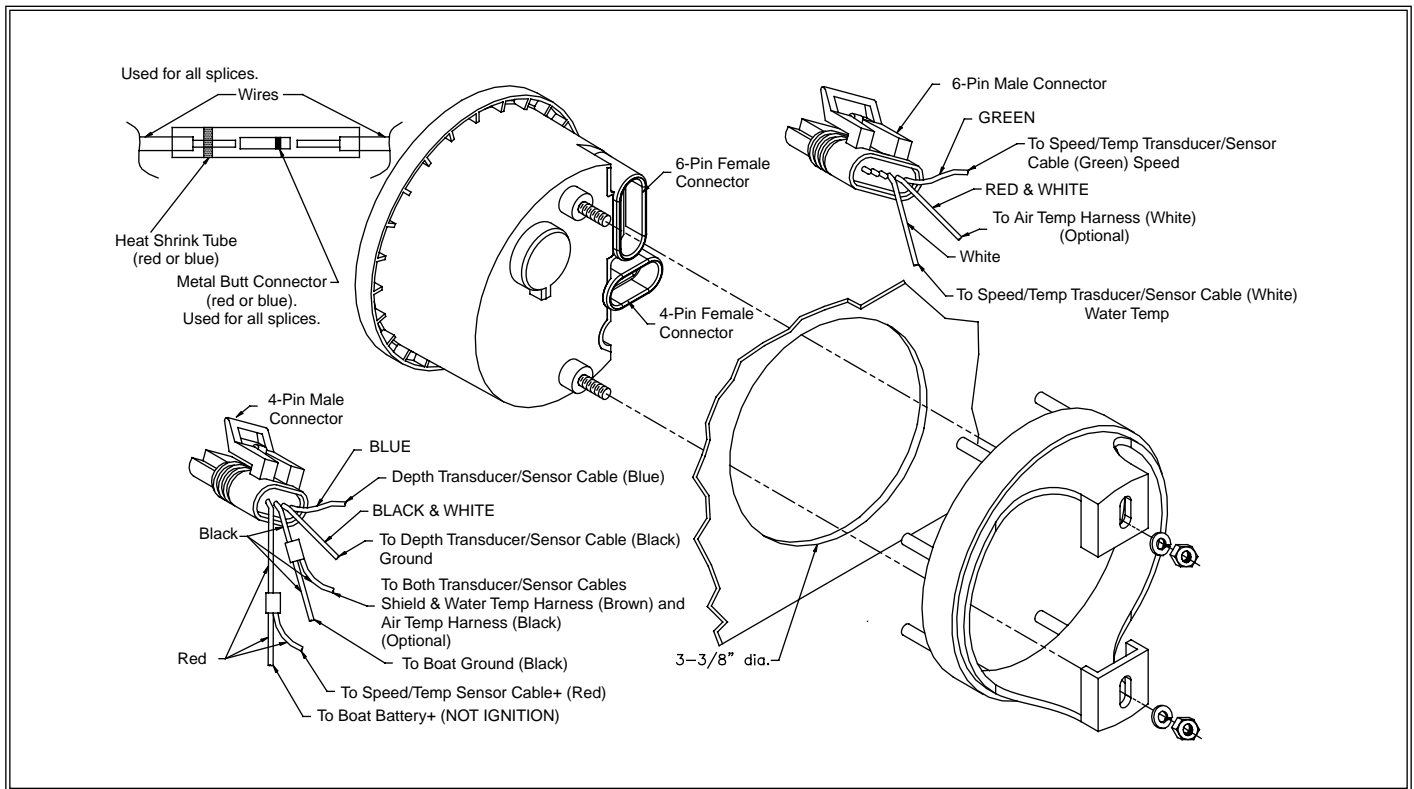

Installation:

CAUTION: Disconnect the battery during installation. Tighten nuts on the back clamp only slightly more than you can tighten with your fingers. Six **inch-pounds** of torque are sufficient. Over-tightening could result in damage to the instrument and may void your warranty.

1. Cut a 3-3/8" diameter hole in the dash and mount the gauge with the back clamp supplied.

Follow the enclosed Airmar Technology Corporation instructions for installing the transducer/sensor. Once the transducer/sensor is installed and you have lead the cables to the Pilot, connect the wires from the transducer/sensor to the corresponding 4 or 6-pin connectors as illustrated using the butt connectors supplied. The butt connectors have a heat activated waterproofing. Once the butt connections have been crimped slowly apply heat with a heat gun until you see sealant coming out of the connector ends. It is recommended to wrap the connections together with electrical tape for further protection.

(4 - Pin Connector)

2. It is recommended that insulated wire terminals, preferably ring type, be used on the connections to the power source. Be certain to use stranded, insulated wire, not lighter than 18 gauge, that is approved for marine use.

3. Connect a wire to the boat's electrical ground usually available at several locations near the instrument panel. Connect the other end to one of the connector's *black*

wires to the transducer/sensor cable *shielding*; the water temp harness *brown* (optional: and air temp harness *black*) using a *blue* connector.

4. Connect the red wire to any continuous B+ or positive "+" circuit of the boat's 12 Volt DC electrical system. **This circuit must not be ignition key activated as the clock requires a very small but continuous B+ supply.** Using red connectors: Connect the other end to one of the connector's red wires. Connect the connector's other wire to the transducer/sensor cable *red*.

5. Connect the connector's *black & white* wire to the transducer/sensor cable *black*, using a *red* connector.

6. Connect the connector's *blue* wire to the transducer/sensor cable *blue*, using a *red* connector.

(6 - Pin Connector)

1. Connect the connector's *white* wire to the transducer/sensor cable *white*, using a *red* connector.

2. Connect the connector's *green* wire to the transducer/sensor cable *green*, using a *red* connector.

3.(Optional: Connect the connector's *red* and *white* wire to the air temp harness *white*, using a *red* connector)

NOTE: If the transducer cables are not connected properly or not plugged into the Pilot, the display will blink when the power is applied to the unit.

Operation:

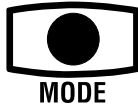

Power ON:

To turn the Pilot on, **press the MODE button** on the top of the instrument. The Pilot will beep and the LCD will illuminate and display the functions last selected.

Power OFF:

To turn the Pilot off, **press and hold the MODE button**. The Pilot will beep. Continue holding the MODE button. The top display will show “FF” and the bottom display will count down: 3, 2, 1. The LCD will then extinguish.



Illumination On:

To turn on the dial illumination, **press the right Up (▲) arrow** with the Pilot in the normal mode.

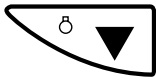

Illumination Off:

To turn off the dial illumination, **press the left Down (▼) arrow** with the Pilot in the normal mode.

Normal Mode:

Pilot is operating showing the last selected Functions.

NOTE: When in either the Select or Edit Modes if no button is pushed for 5 seconds the Pilot will revert to the Normal Mode functions last used or to the new settings. If no button is pushed for 24 hours the Pilot will shut off.

Select Mode:

The Select Mode allows selection of the upper or lower LCD displays and or the particular function desired in either display.

Activating the Select Mode:

To activate the Select Mode, **press the MODE button quickly**. The Pilot will beep and the last selected active display (upper or lower) will flash.

Selecting upper or lower active display:

Activate the Select Mode and **while the display is flashing, press the Up arrow (▲) to select the upper**

display as active or the Down arrow (▼) to select the lower display as the active display.

Selecting display function, (moving the Function Indicator):

When in the Select Mode in the desired active display and **while the display is flashing press the MODE button quickly again**. The Function Indicator will move from function to function around the selected active display and the Pilot will beep each time the MODE button is pressed. Stop at the desired function.

Edit Mode:

The Edit Mode allows you to set the following:

Depth Sounder: shallow alarm, deep alarm, keel offset, scale units (feet, fathoms or meters).

Timer: reset to zero.

Clock: hours and minutes.

Distance Log: reset to zero, speed scale units (miles per hour or knots,) calibrate speed and distance (statute miles or nautical miles).

Thermometers air and water: scale units (Fahrenheit or Centigrade).

Selecting the Edit Mode:

When the desired display function is selected, **press and hold the MODE button until the Pilot beeps**. The Edit Mode will activate. If no buttons are pushed within 5 seconds, the Pilot will revert automatically to the Normal Mode. You can also enter the Edit Mode while in the Select Mode. The Pilot display will then stop flashing (Select Mode) indicating the change to the Edit Mode. The operation of various edit modes will be separately explained for each function throughout this manual.

Upper Display Functions

Depth Sounder:

Description:

Depending on the bottom conditions the depth finder will read to 300ft. or the corresponding number of meters or fathoms to the nearest 1/10th (0.1). NOTE: A 600 ft. Triducer is also available.

The depth finder has an audible and LCD displayed depth alarm with adjustable shallow and deep limits and a depth below keel offset feature. These settings once made are stored in memory and will remain even if the battery is disconnected.

Depth Sounder Continued:



Operation:

Selecting the Depth Sounder Function:

Press the **MODE** button and activate the Select Mode.

Press the **Up (▲)** arrow to select the upper display.

Continue pressing the **MODE** button again until the Function Indicator is pointing to **FT**, **M** or **FA**.

(The Function Indicator will automatically point to the last unit type selected. You are now in the Depth Finder function.)

Selecting the depth Sounder Units.

Press and hold the **MODE** button until the Pilot beeps to select the Edit Mode. Continue pressing the **MODE** button quickly until the upper display reads "┐┐" (units).

Press either arrow button (**▲**) / (**▼**) to move the function indicator to the desired units either Feet (**F**), Meters (**M**) or Fathoms (**FA**).

Depth alarms:

When the shallow depth setting is read by the depth sounder, the Function Indicator will flash on the LCD next to the "**S**" and the audible alarm will sound rapidly. When the deep depth setting is read by the depth sounder, the Function Indicator will flash on the LCD next to the "**D**" and the audible alarm will sound at 2 beeps per second.

NOTE: Once a keel offset is programmed, the depth below the keel will activate the shallow and deep alarms.

NOTE: To fully deactivate an alarm, reset it to zero.

Setting the Shallow Alarm:

Press and hold the **MODE** button until the Pilot beeps to select the Edit Mode. Continue pressing the **MODE** button quickly until the Function Indicator points to the "**S**" indicating the shallow depth alarm setting. This is the shallowest water that will activate the alarm. Press and hold the **Up or Down arrow keypads (▲) / (▼)** to adjust the reading to the desired depth.

Setting the Deep Alarm:

Press and hold the **MODE** button until the Pilot beeps to select the Edit Mode. Continue pressing the **MODE** button quickly until the Function Indicator points to the "**D**" indicating the deep depth alarm setting. This is the deepest water that will activate the alarm. Press and hold the **Up or Down arrow keypads (▲) / (▼)** to adjust the reading to the desired depth.

Setting the Keel Offset:

Keel Offset can be set so that the depth sounder either shows the depth below the keel, (set the offset to be the depth between the transducer and the bottom of the keel) or the depth below the transducer (set the offset to 0). For example if the bottom of the keel is 2 ft. below the transducer and you want the depth sounder to read the depth below the keel, the display should be adjusted to read minus -2.0 "FT".

Press and hold the **MODE** button until the Pilot beeps to select the Edit Mode. Continue pressing the **MODE** button quickly until the Function Indicator points to the "**KL**" indicating the keel offset function. Press and hold the **Up or Down arrow keypad (▲) / (▼)** to adjust the reading to the desired depth. A minus sign (-) will appear to the left of the setting.

Loss of Signal:

If the signal is lost due to depths below 300 ft., depths above 2 ft. or a disconnected or broken cable, a dashed line will appear in the upper display signifying loss of signal. If the upper display depth sounder function is active the dashed line will illuminate and hold. If any other upper display function is active the dashed line will flash on and off alternately with the active function's readout.

Timer:

Description:

The timer operates simultaneously in hours, minutes and seconds. The timer is viewed in the Normal Mode as either hours and minutes (**T1**), or minutes and seconds (**T2**).

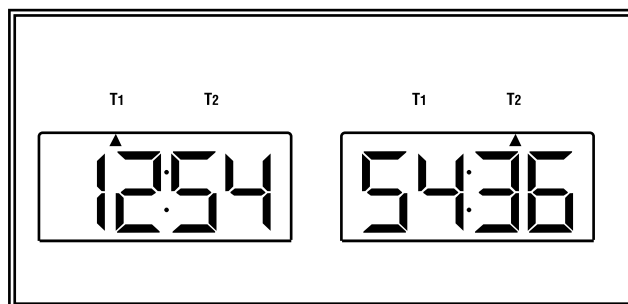

Operation:

Selecting the Timer Functions.

Press the **MODE** button and activate the Select Mode.
Press the **Up (▲)** arrow to Select the upper display.
Continue pressing the **MODE** button again until the Function Indicator is pointing to either (T1) or (T2).

Starting and Stopping the Timer.

Press either arrow button (▲)/(▼) to start or stop the timer at any time.

Resetting the Timer.

Press and hold the **MODE** button until the Pilot beeps to select the Edit Mode. Selecting the Edit Mode in either (T1) or (T2) will reset the timer to zero.

Clock:

Description:

The clock will run continuously as long as power is applied to the Pilot. The clock reads hours and minutes.

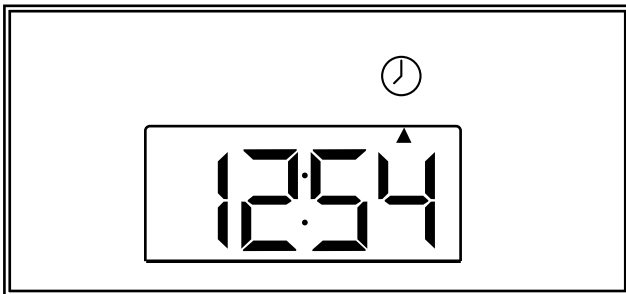

Operation:

Selecting the Clock Function.

Press the **MODE** button and activate the Select Mode.
Press the **Up (▲)** arrow to select the upper display.
Continue pressing the **MODE** button again until the Function Indicator is pointing to the clock.

Setting the clock:

Press and hold the **MODE** button until the Pilot beeps to select the Edit Mode. Press the **Up or Down arrow keypads once (▲)/(▼)** to set each minute. Press and hold the **Up or Down arrow keypads (▲)/(▼)** to set the hours. (The minutes will continuously advance in 10-minute intervals to change the hours.)

Hourmeter:

Description:

The hourmeter is designed to activate when the line voltage to the Pilot reaches 13.6v DC. This voltage would indicate that the system is charging with the engine running.

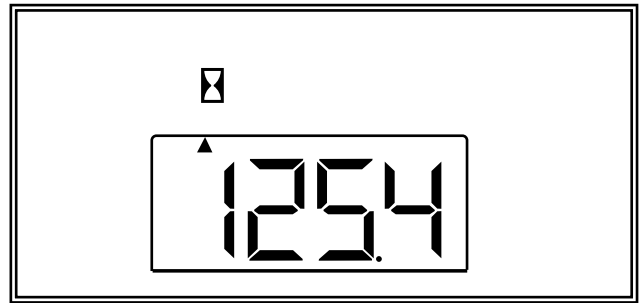

Selecting the Hourmeter:

Press the **MODE** button and activate the Select Mode.
Press the **Up (▲)** arrow to select the upper display.
Continue pressing the **MODE** button again until the Function Indicator is pointing to the Hourglass.

Lower Display Functions

Speedometer & Distance Log:

Description:

The Speedometer gives digital readings in either Statute Miles per Hour or Nautical Miles per Hour (knots). Readings are accurate up to 58 mph (50 kts) in 0.1 increments. Speed calibration can be performed at any speed by setting the speedometer reading to match GPS, radar gun, time distance run etc. The Distance Log reads in either Statute Miles or Nautical Miles in 0.1 increments depending upon which unit type is selected for the Speedometer or Log. (Setting units in either function sets the units for both). Distance Log calibration can also be performed by setting the Log reading to match a GPS or charted distance run. Calibrating the distance Log also automatically calibrates the Speedometer. (The longer the distance the more accurate the calibration.)

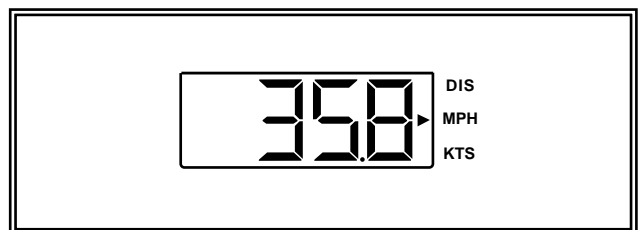

Operation:

Selecting the Speedometer Function:

Press the **MODE** button and activate the Select Mode.
Press the **Down arrow (▼)** to select the lower display.
Continue pressing the **MODE** button again until the Function Indicator is pointing to either (MPH) or (KTS). (The Function Indicator will automatically point to the last unit type selected. You are now in the Speedometer function.)

Selecting the Speedometer Units.

Press and hold the MODE button until the Pilot beeps to select the Edit Mode. Continue pressing the MODE button quickly until the lower display reads “┐┐” (units).

Press either arrow button (▲) / (▼) to move the function indicator to the desired units either Miles per Hour (MPH), or Knots (KTS).

Calibrating the Speedometer:

Press and hold the MODE button until the Pilot beeps to select the Edit Mode. Continue pressing the MODE button quickly until the lower display reads “□” (calibration). Press either arrow button (▲) / (▼) to change the speed reading to the desired speed.

Selecting the Distance Log Function:

Press the MODE button and activate the Select Mode.

Press the Down arrow (▼) to select the lower display.

Continue pressing the MODE button again until the Function Indicator is pointing to (DIS). The Function Indicator will also automatically point to the last unit type selected. You are now in the Distance Log Function

Selecting the Distance Log Units.

Press and hold the MODE button until the Pilot beeps to select the Edit Mode. Continue pressing the MODE button quickly until the lower display reads “┐┐”(units).

Press either arrow button (▲) / (▼) to move the function indicator to the desired units either Miles (MPH), or Nautical Miles (KTS).

Calibrating the Distance Log:

Press and hold the MODE button until the Pilot beeps to select the Edit Mode. Continue pressing the MODE button quickly until the lower display reads “□” (calibration). Press either arrow button (▲) / (▼) to change the Log reading to the desired distance.

Clearing the Distance Log:

Press and hold the MODE button until the Pilot beeps to select the Edit Mode. Continue pressing the MODE button quickly until the lower display reads “┐┐”(clear).

Press either arrow button (▲) / (▼) to clear the Log reading to zero.

Water and Air / Bait-well Temperature:

Description:

The Pilot will monitor water surface temperature. The (Setting units Fahrenheit (F), or Centigrade (C), in either function sets the units for both). (A second temperature, either air or bait-well may be monitored when the unit is equipped with the optional sender.)

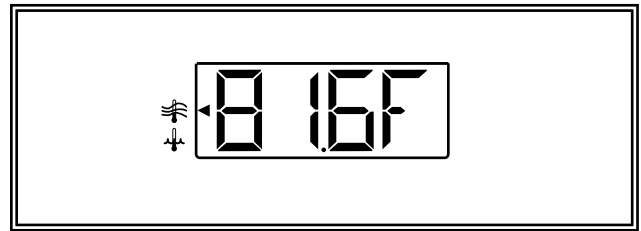

Operation:

Selecting the Air / Water Temperature Function

Press the MODE button and activate the Select Mode.

Press the Down arrow (▼) to Select the lower display.

Continue pressing the MODE button again until the Function Indicator is pointing to either the upper icon (Air/Bait-well Temp.) or the lower icon (Water Temp.)

Selecting the Air / Water Temperature Units

Press and hold the MODE button until the Pilot beeps to select Edit Mode. Continue pressing the MODE button quickly until the lower display reads “┐┐” (units).

Press either arrow button (▲) / (▼) to move the function indicator to the desired units either Fahrenheit (F) or Centigrade (C).

Voltmeter:

Description:

The Voltmeter continuously monitors the 12v DC power supplied to the Pilot. The Voltmeter has a low and high voltage alarm feature. If line voltage drops to 10v DC or rises above 16v DC the Voltmeter Function will automatically activate. The LCD display will flash and the Pilot will Beep every 15 seconds to warn of a low or high voltage condition. If voltage lower than 13v DC persists for 24 hours the Pilot will shut off.

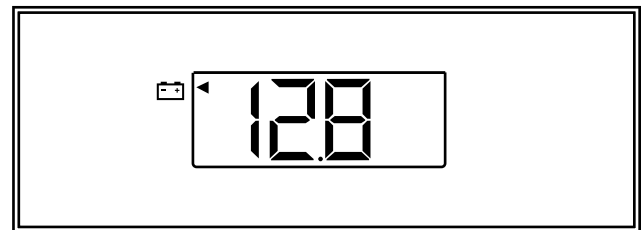

Selecting the Voltmeter Function:

Press the MODE button and activate the Select Mode.

Press the Down arrow (▼) to select the lower display.

Continue pressing the MODE button again until the Function Indicator is pointing to the Battery icon.

Faria[®]
IS0123B ECR#867